



<http://wiki.homerecz.com>

.....	1
.....	1
.....	1
.....	1
U87	5
Specification	5
K87	6
Schematic	7
.....	9
.....	9
.....	9
.....	9

U87

U87

U67

Neumann

(FET)

K87
가

가

¹⁾

U67

K67

가

, U87 U67

Neumann U87
48V DC

K87

3가

²⁾



Neumann U87

가

U87ai

- U87 : [DIN 7](#) (Tuchel)
- U87i : [XLR](#) , i: International

Specification

- : K87
- :
- : 40Hz~16,000Hz
-

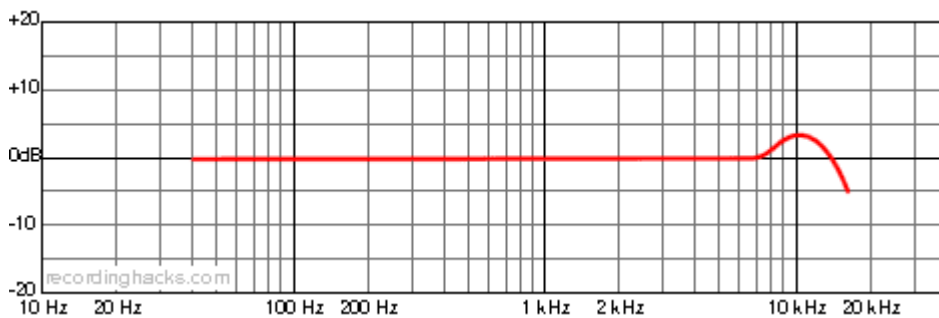

-

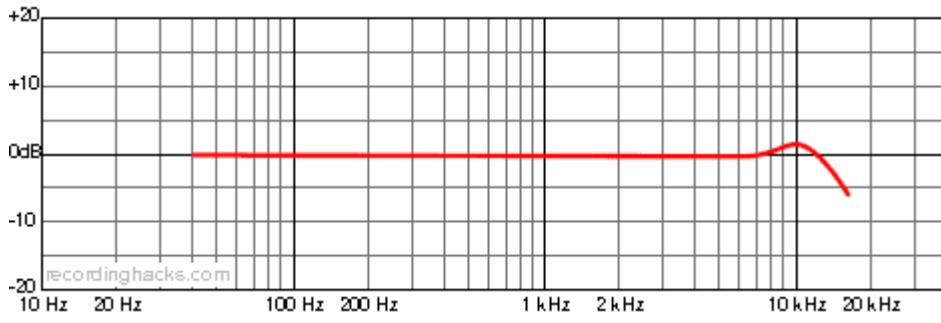

-

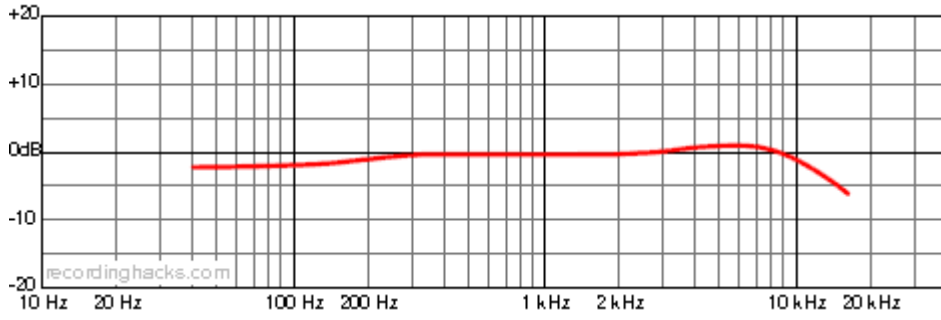

- : 8mV/Pa ± 1mV
- : 150Ω
- : 18dBA
- MaxSPL : 0.5% THD@122dB SPL, 1kHz (10dB 132dB)

K87

- 34mm
- 24mm, Mylar()
- ,
- Center-terminated



Schematic

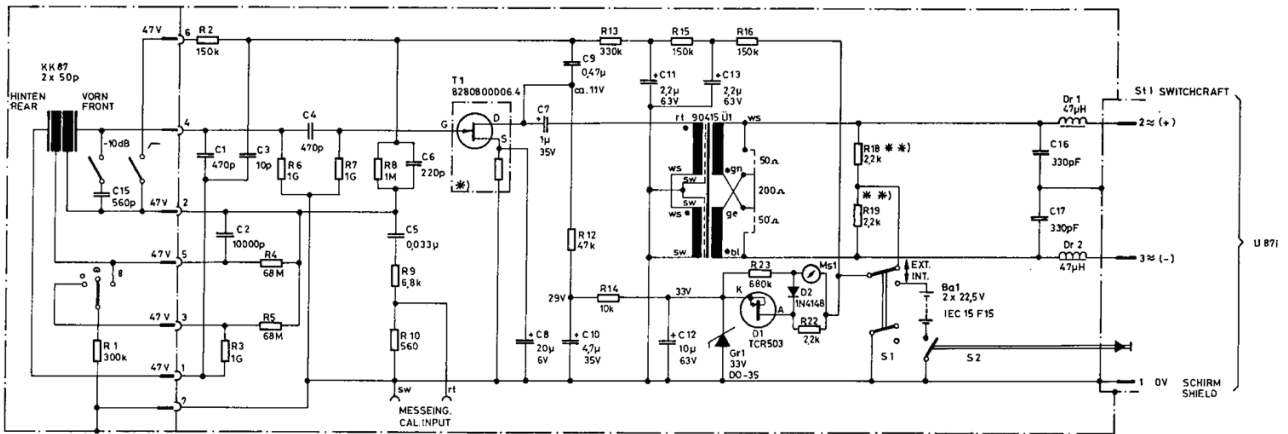

COLORS

GERMAN	AMERICAN
RT	RED
WS	WHT
SW	BLK
GN	GRN
GE	YEL
BL	BLU

PHANTOMSPESUNG DIN 45596
 PHANTOM-POWERING DIN 45596
 = 48V, 0.45mA

(+) = POLARITÄT BEI DRUCKANSTIEG VOR DER MEMBRAN
 POLARITY FOR A SUDDEN RISE OF SOUND PRESSURE
 IN FRONT OF THE MEMBRANE

*) ABGEGLICHEN
 SELECTED

**) PAARWEISE AUF GLEICHEN WERT (± 0.4%) AUSGESUCHT
 SELECTED IN PAIRS OF IDENTICAL VALUE (± 0.4%)

Diese Zeichnung ist unser Eigentum. Jede Vervielfältigung,
 Verwertung oder Mitteilung an dritte Personen ist strafbar
 und wird gerichtlich verfolgt. (Urheberrechtsgesetz, Gesetz
 gegen unlauteren Wettbewerb, B. G. B.).



AUF DIE LÖTANSCHLÜSSE
 GESEHEN!
 SOLDERING SIDE VIEW!

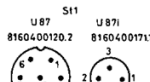

AUF DIE STECKER
 GESEHEN!
 PIN VIEW!

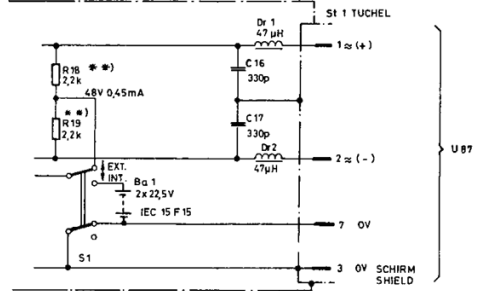

KONDENSATOR MIKROPHON U87, U87i
 CONDENSER MICROPHONE U87, U87i
 10241 901 21.7



GEORG NEUMANN GMBH

BERLIN

<http://recordinghacks.com/>

11.9.80%

IRRTÖMER UND TECHNISCHE ÄNDERUNGEN VORBEHALTEN ERRORS EXCEPTED SUBJECT TO CHANGES

1)

U87ai K67

2)

U87ai K67

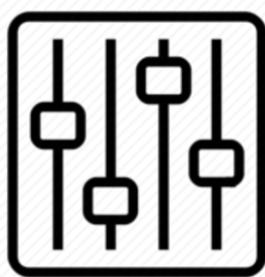

<http://wiki.homerecz.com>

From:
<https://wiki.homerecz.com/> -

Last update: **2024/06/20**

: (admin@homerecz.com)